



Kataloglarımızda bulunan profil çizimleri örnek olarak konulmuştur.  
Müşterilerimize ait olan çizimlerin profilleri satılamaz.

Profile drawings in our catalogues are given as examples only.  
Profiles in drawings belonging to our customers are not for sale.

Les profilés qui figurent dans nos catalogues sont présentés à titre d'exemple.  
Les profilés fabriqués à partir des dessins de nos clients ne sont pas mis à la vente.

Чертежи профилей из наших каталогов приложены в качестве образцов.  
Профили, выполненные по чертежам наших клиентов, не продаются.

---

DUŞ KABİN PROFİLLERİ  
SHOWER PROFILES  
PROFILES DE DOUCHE  
ДУШ ПРОФИЛИ

---

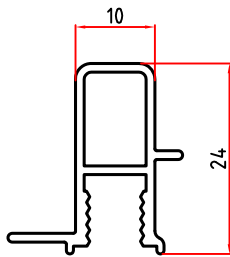

2701  
0,255 Kg/m

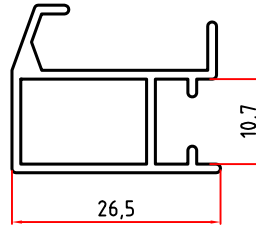

2702  
0,311 Kg/m

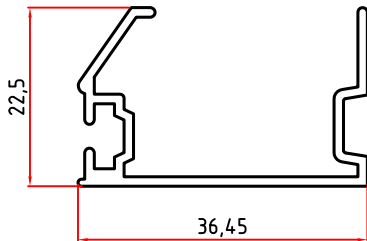

2703  
0,347 Kg/m

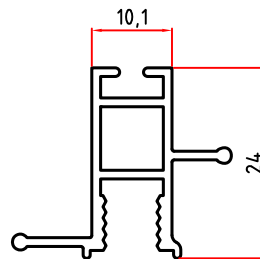

2704  
0,300 Kg/m

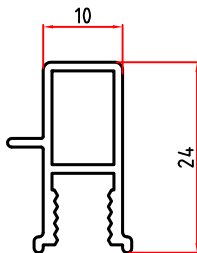

2705  
0,237 Kg/m

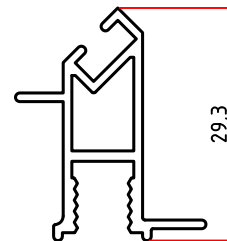

2706  
0,310 Kg/m

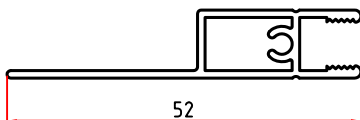

2707  
0,322 Kg/m

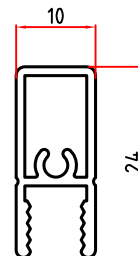

2708  
0,240 Kg/m

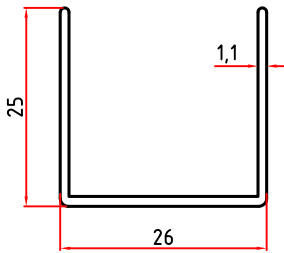

**2709**  
0,239 Kg/m

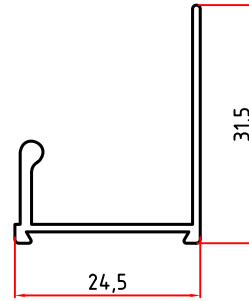

**3083**  
0,224 Kg/m

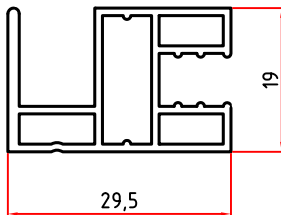

**3084**  
0,422 Kg/m

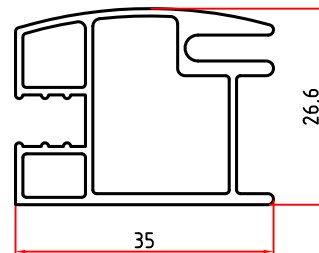

**3085**  
0,594 Kg/m

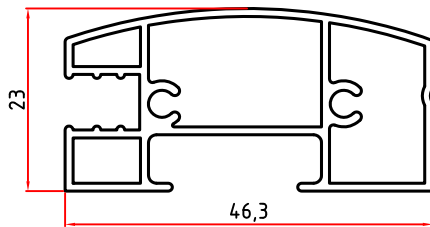

**3087**  
0,596 Kg/m

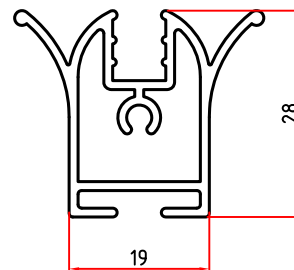

**3089**  
0,525 Kg/m

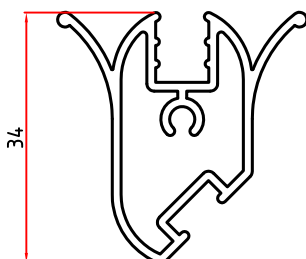

**3092**  
0,522 Kg/m

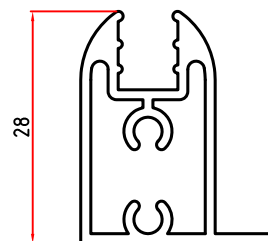

**3093**  
0,452 Kg/m

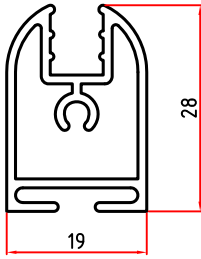

**3094**  
0,437 Kg/m

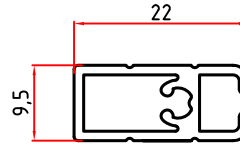

**3184**  
0,239 Kg/m

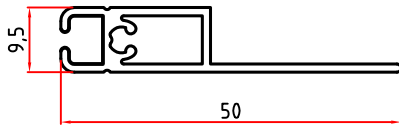

**3185**  
0,336 Kg/m

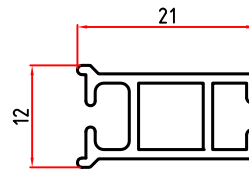

**3186**  
0,219 Kg/m

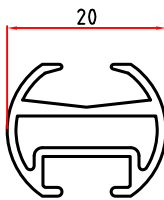

**4307**  
0,277 Kg/m

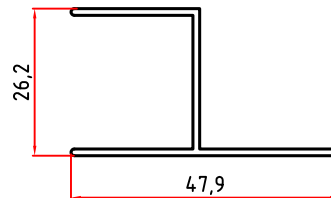

**2710**  
0,406 Kg/m

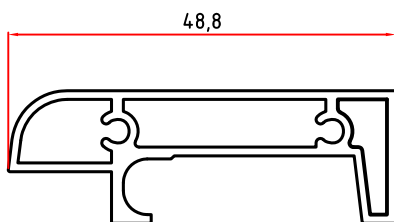

**6163**  
0,527 Kg/m

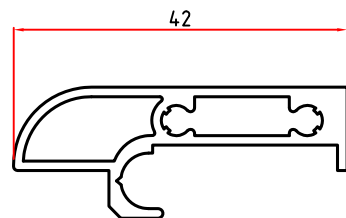

**5889**  
0,476 Kg/m

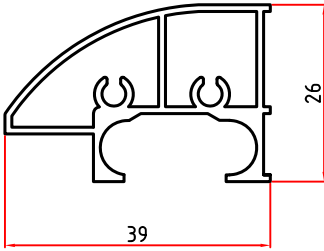

**5031**  
0,532 Kg/m

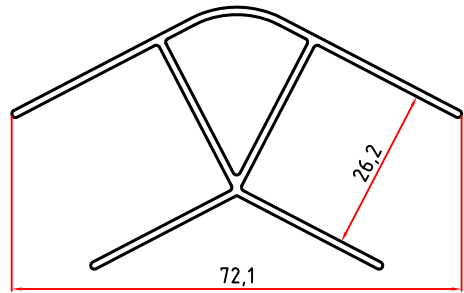

**5032**  
0,630 Kg/m

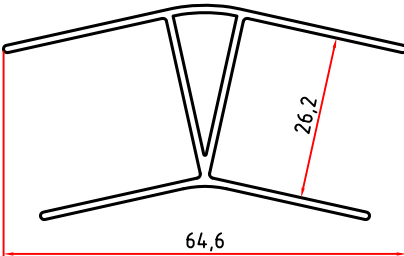

**5033**  
0,586 Kg/m

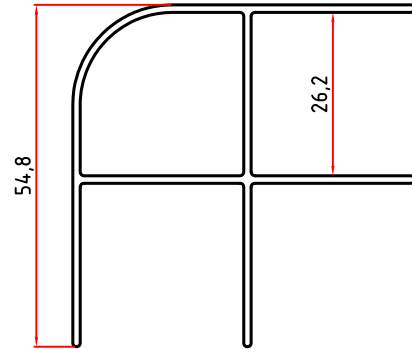

**5034**  
0,709 Kg/m

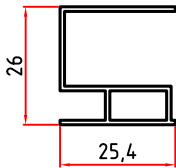

**5035**  
0,298 Kg/m

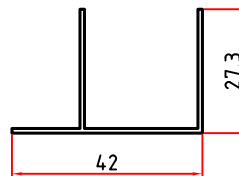

**5036**  
0,269 Kg/m

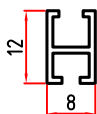

**5037**  
0,100 Kg/m

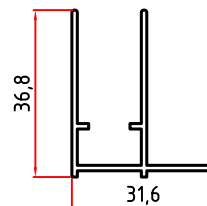

**5062**  
0,372 Kg/m

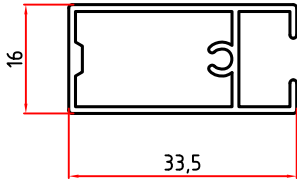

**5063**  
0,325 Kg/m

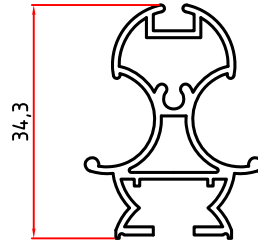

**5064**  
0,442 Kg/m

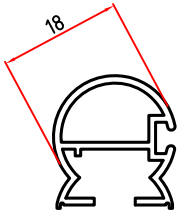

**5065**  
0,234 Kg/m

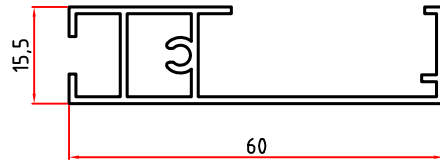

**5066**  
0,464 Kg/m

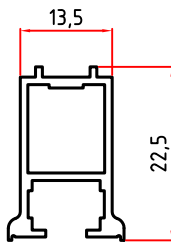

**5067**  
0,289 Kg/m

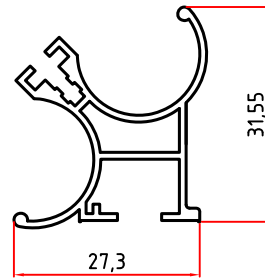

**5068**  
0,392 Kg/m

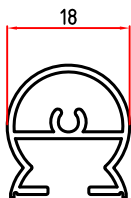

**5069**  
0,235 Kg/m

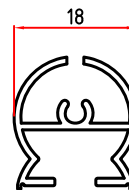

**5070**  
0,228 Kg/m

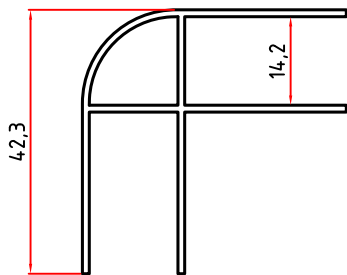

**5071**  
0,496 Kg/m

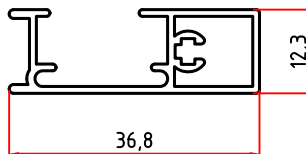

**5072**  
0,313 Kg/m

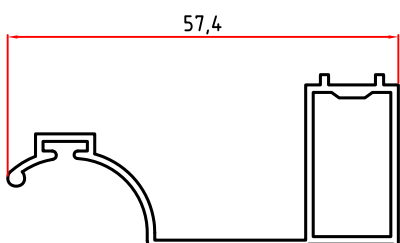

**5073**  
0,445 Kg/m

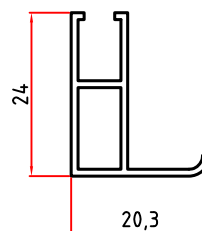

**5074**  
0,214 Kg/m

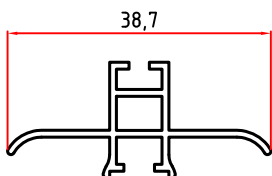

**5075**  
0,245 Kg/m

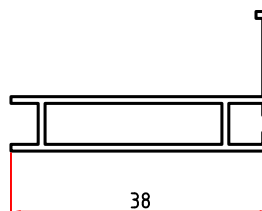

**5076**  
0,299 Kg/m

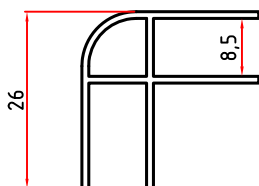

**5077**  
0,275 Kg/m

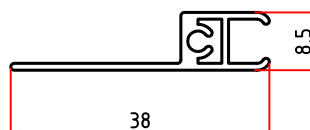

**5078**  
0,213 Kg/m

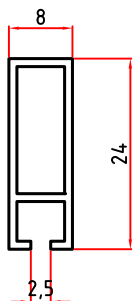

**5079**  
0,181 Kg/m

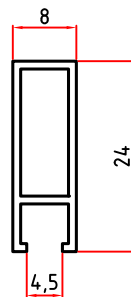

**5080**  
0,175 Kg/m

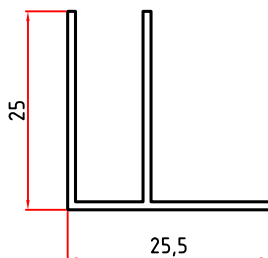

**5081**  
0,209 Kg/m

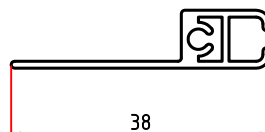

**5082**  
0,219 Kg/m

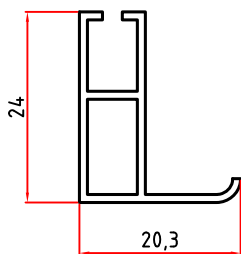

**5085**  
0,220 Kg/m

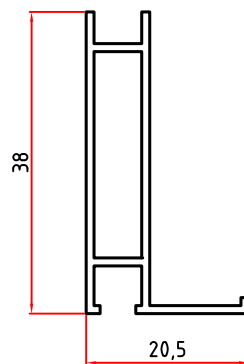

**5086**  
0,293 Kg/m

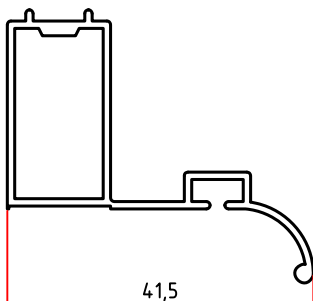

**5087**  
0,373 Kg/m

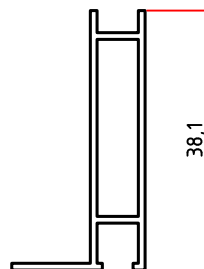

**5106**  
0,289 Kg/m



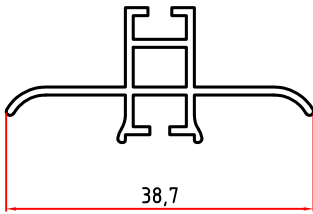

**5107**  
0,251 Kg/m

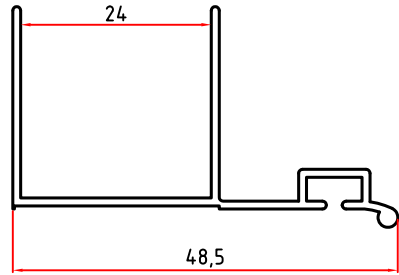

**5271**  
0,320 Kg/m

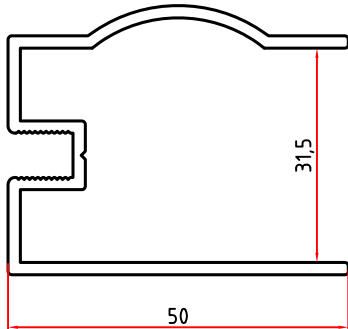

**5319**  
0,772 Kg/m

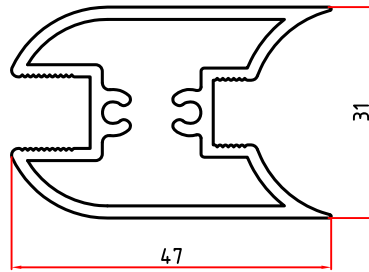

**5320**  
0,980 Kg/m

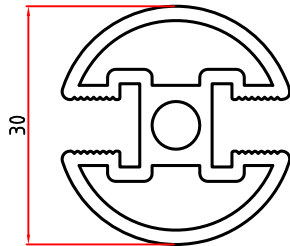

**5321**  
0,784 Kg/m

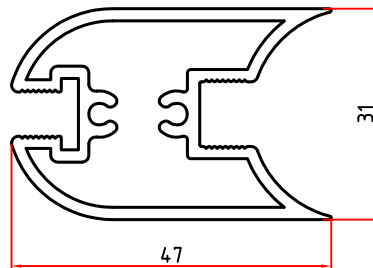

**5322**  
1,005 Kg/m

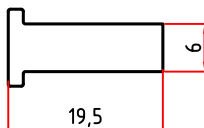

**5323**  
0,352 Kg/m



**5352**  
0,056 Kg/m



**5353**  
0,109 Kg/m

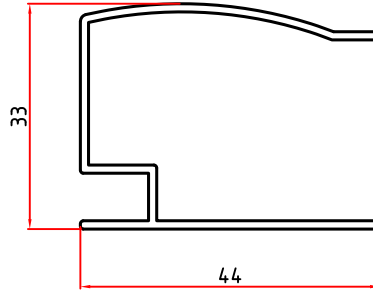

**5354**  
0,434 Kg/m

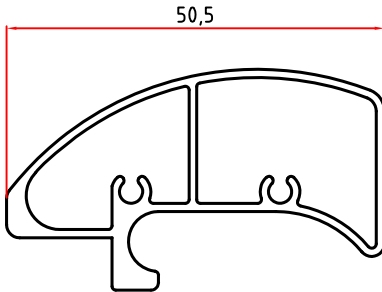

**5355**  
0,653 Kg/m

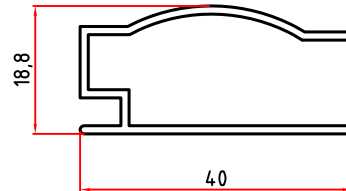

**5663**  
0,342 Kg/m

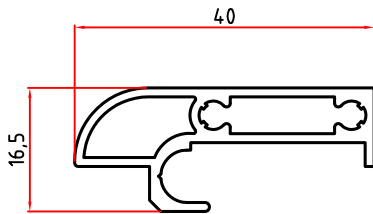

**5664**  
0,441 Kg/m

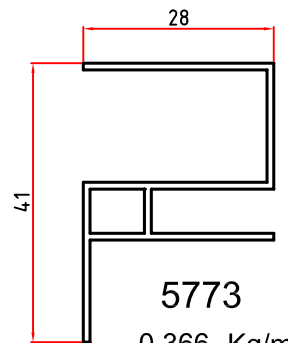

**5773**  
0,366 Kg/m

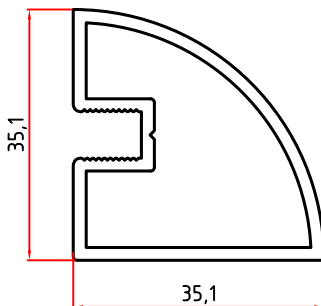

**5833**  
0,697 Kg/m

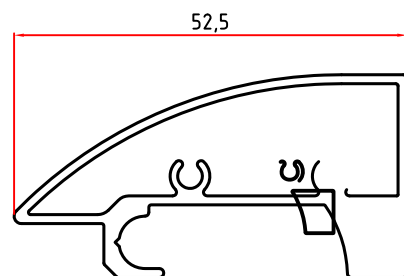

**5885**  
0,672 Kg/m

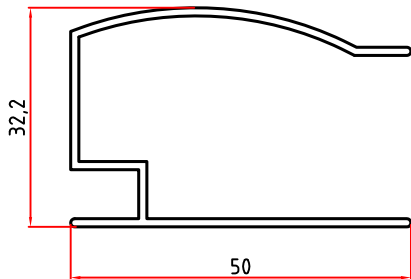

**5886**  
0,469 Kg/m

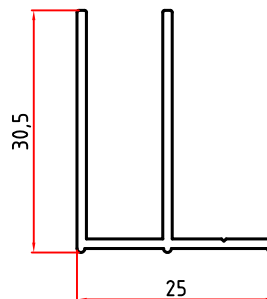

**5887**  
0,285 Kg/m

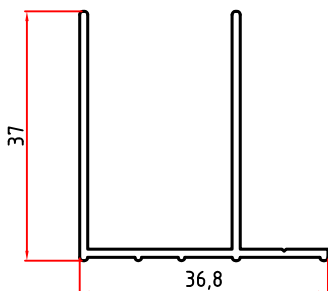

**5888**  
0,372 Kg/m

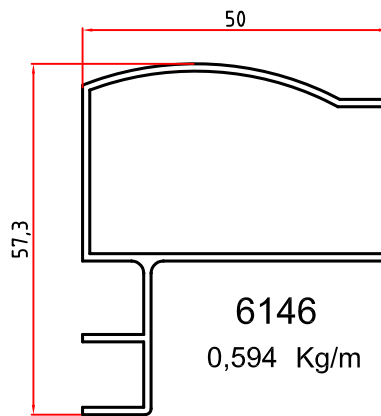

**6146**  
0,594 Kg/m

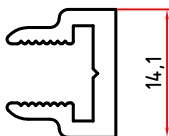

**5992**  
0,206 Kg/m

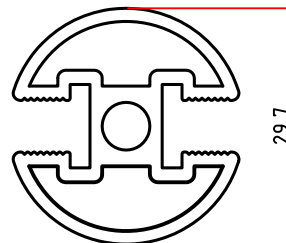

**6014**  
0,751 Kg/m

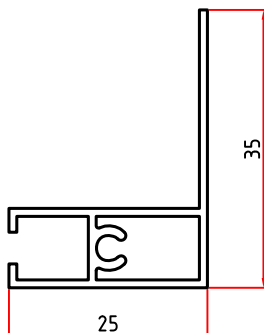

**6090**  
0,298 Kg/m

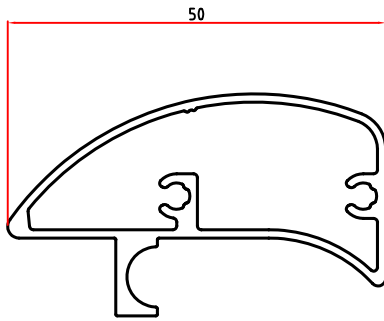

7190  
0,588 Kg/m

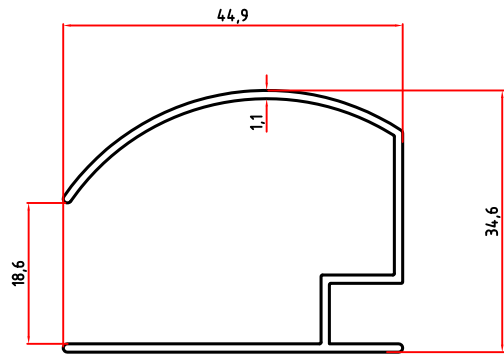

7191  
0,413 Kg/m

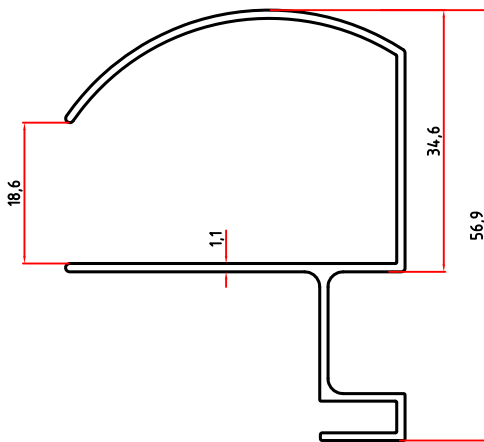

7192  
0,518 Kg/m

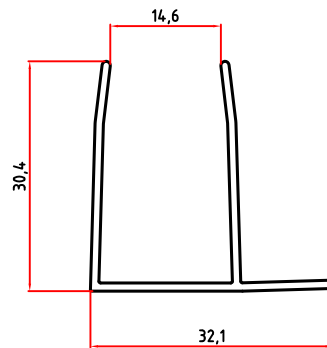

7193  
0,283 Kg/m

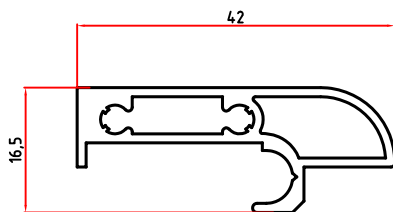

5889  
0,476 Kg/m

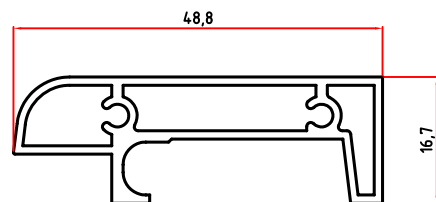

6163  
0,527 Kg/m

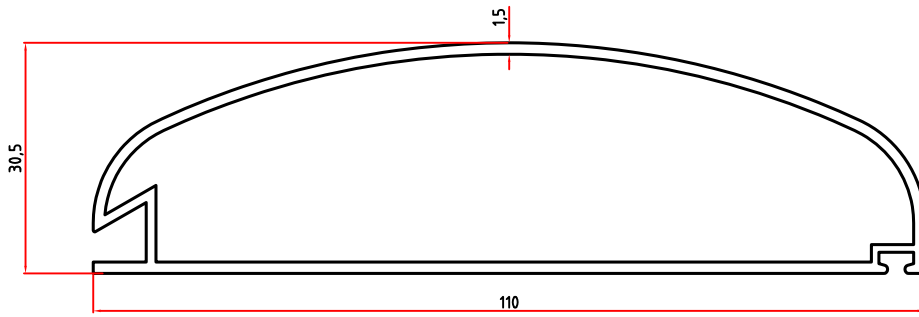

5216  
1,105 Kg/m

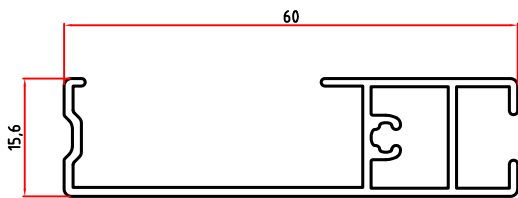

7258  
0,470 Kg/m

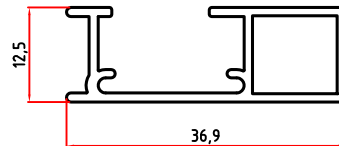

7259  
0,315 Kg/m