



Kataloglarımızda bulunan profil çizimleri örnek olarak konulmuştur.
Müşterilerimize ait olan çizimlerin profilleri satılamaz.

Profile drawings in our catalogues are given as examples only.
Profiles in drawings belonging to our customers are not for sale.

Les profilés qui figurent dans nos catalogues sont présentés à titre d'exemple.
Les profilés fabriqués à partir des dessins de nos clients ne sont pas mis à la vente.

Чертежи профилей из наших каталогов приложены в качестве образцов.
Профили, выполненные по чертежам наших клиентов, не продаются.

REKLAM PROFİLLERİ
BILLBOARD PROFILES
PROFILES PUBLICITAIRES
РЕКЛАМНЫЕ ПРОФИЛИ

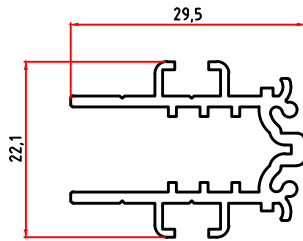

6667

0,402 Kg/m

(6183-6145-6445-6367-6227)

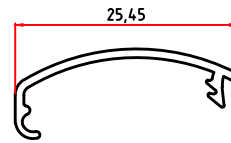

6518

0,107 Kg/m

(2872-6667)

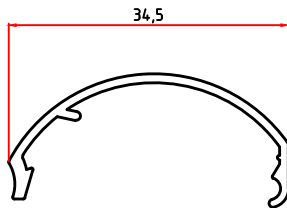

6445

0,185 Kg/m

(6144-6667-6298)

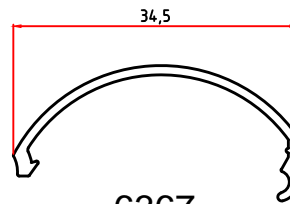

6367

0,168 Kg/m

(6667-6144-6298)

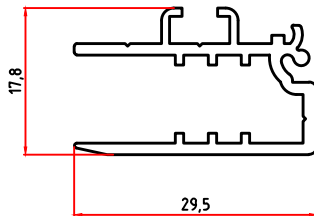

6144

0,349 Kg/m

(6145-6445-6367-6183-6227)

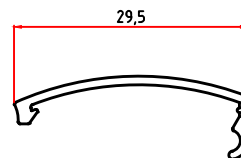

6145

0,132 Kg/m

(6144-6667-6298)

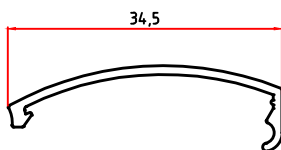

6183

0,149 Kg/m

(6144-6667-6298)

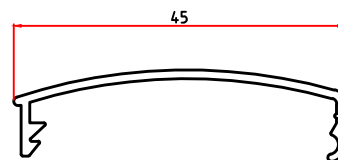

6227

0,221 Kg/m

(6144-6667-6298)

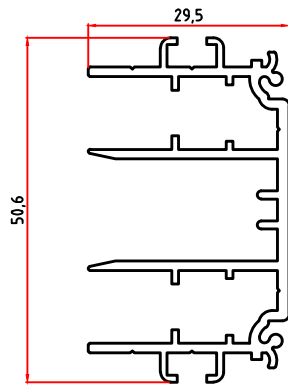

6298

0,787 Kg/m

(6183-6145-6445-6367-6227)

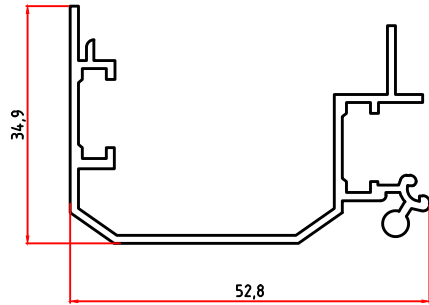

4176

0,561 Kg/m

(4131)

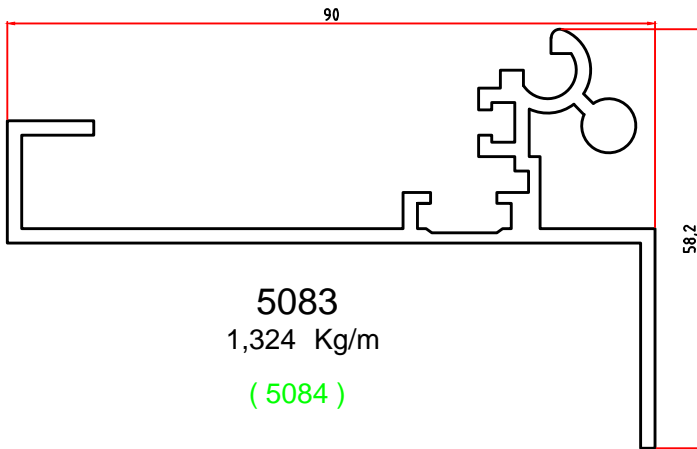

5083

1,324 Kg/m

(5084)

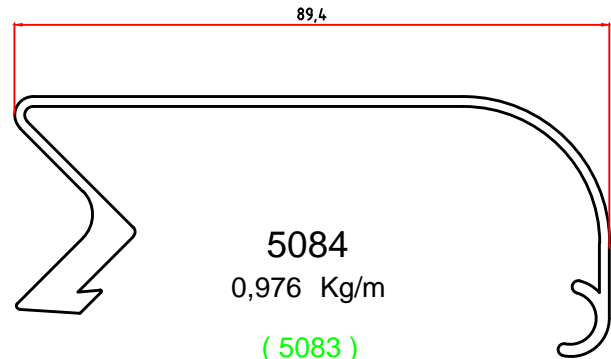

5084

0,976 Kg/m

(5083)

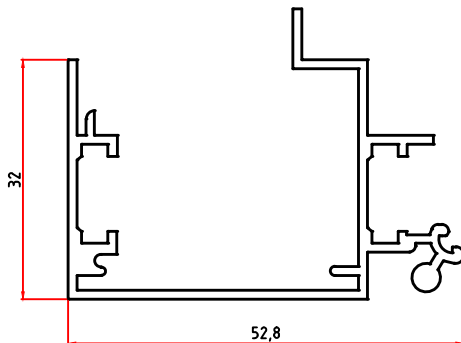

6147

0,651 Kg/m

(1738-2306)

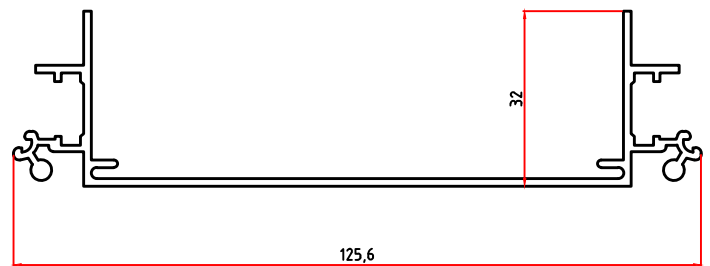

4226

0,985 Kg/m

(1738)

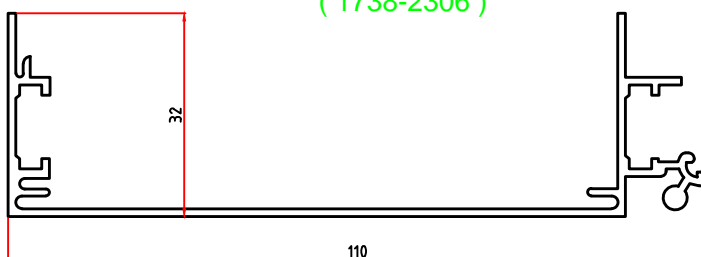

2301

0,796 Kg/m

(2302-1738-4147)

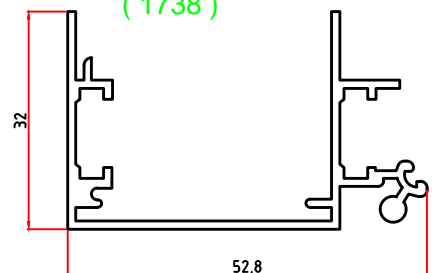

2841

0,598 Kg/m

(2306-1738)

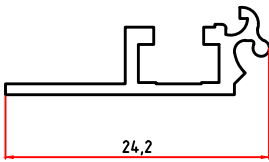

3579

0,133 Kg/m

(3578-2871)

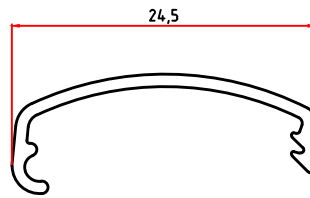

3578

0,108 Kg/m

(2871-3579)

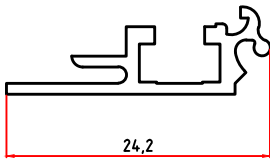

2872

0,149 Kg/m

(2871-3579-6518)

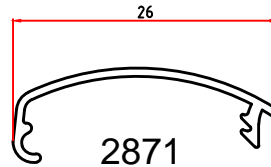

2871

0,091 Kg/m

(2872-3579)

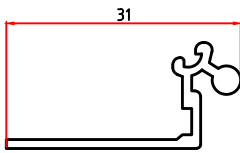

2775

0,194 Kg/m

(1738)

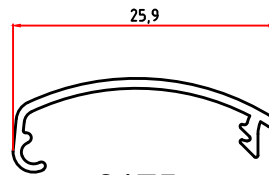

6175

0,107 Kg/m

(2872-3579)

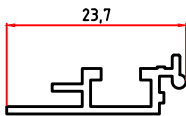

6939

0,135 Kg/m

(6940)

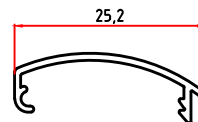

6940

0,097 Kg/m

(6939)

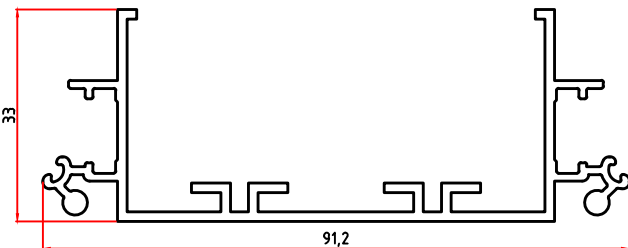

5166

0,990 Kg/m

(2302-3959)

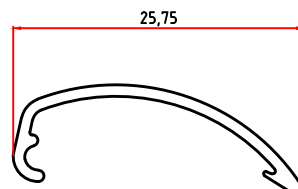

5230

0,105 Kg/m

(2872-3579)

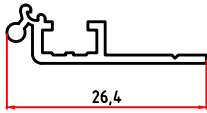

2784
0,137 Kg/m

(2785)

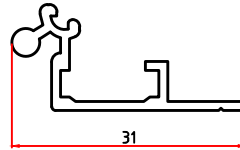

4225
0,219 Kg/m

(1738-5240-3959-6222)

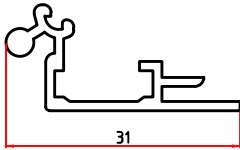

1739
0,242 Kg/m

(1738-6222-5240-3959-4147)

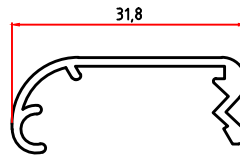

1738
0,226 Kg/m

(1739-4225-2775)

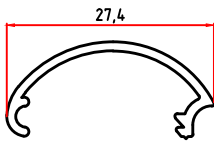

2785
0,157 Kg/m

(2784-3543-3667)

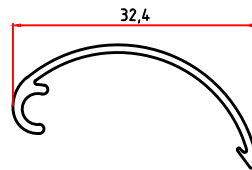

5240
0,156 Kg/m

(1739-4225)

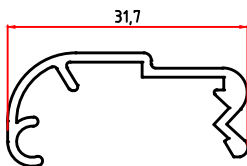

6222
0,247 Kg/m

(1739-4225)

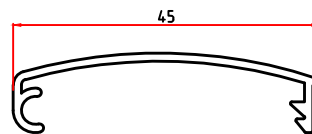

3959
0,233 Kg/m

(1739-2301-4225-2870)

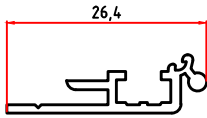

3543
0,155 Kg/m
(2785)

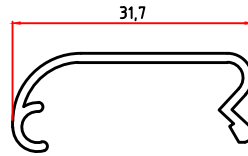

4147
0,199 Kg/m
(1739-4329-2301-2841-4226-6147-4328)

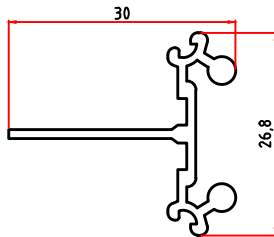

3438
0,298 Kg/m
(3295)

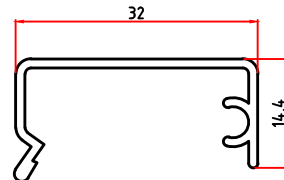

3295
0,236 Kg/m
(3438)

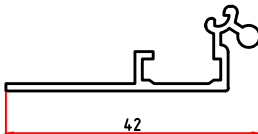

4071
0,258 Kg/m
(2302)

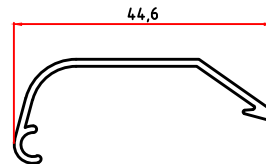

2302
0,230 Kg/m
(2301- 4071-2841-4226-6147-5166)

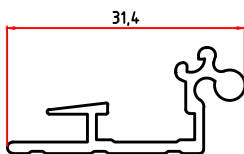

4328
0,253 Kg/m
(1738-4147)

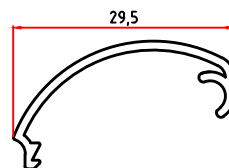

4345
0,172 Kg/m
(4329)

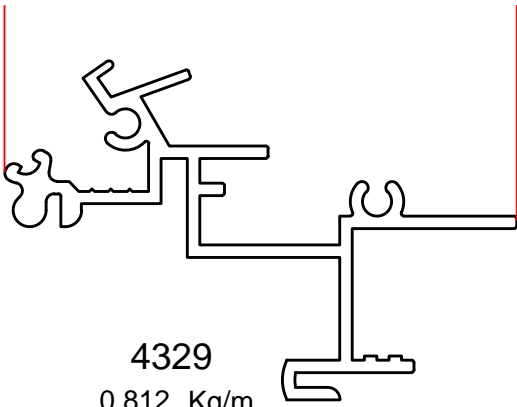

4329
0,812 Kg/m
(4147-4345)

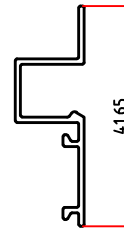

4923
0,217 Kg/m
(4924-4925-4926-4935)

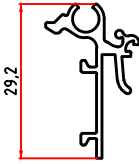

4926
0,244 Kg/m
(4924-4925-4923-4935)

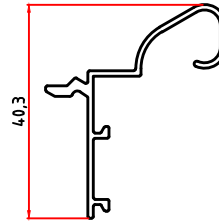

4935
0,279 Kg/m
(4924-4925-4923-4926)

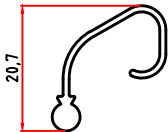

4924
0,164 Kg/m
(4926-4925-4923-4935)

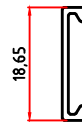

4925
0,081 Kg/m
(4926-4924-4923-4935)

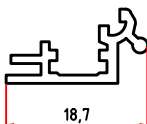

2307
0,141 Kg/m
(2308)

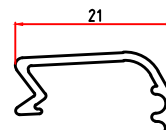

2308
0,124 Kg/m
(2307)

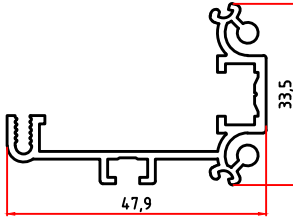

4586
0,606 Kg/m
(4585)

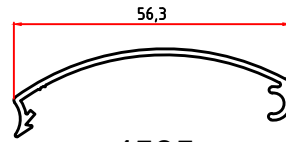

4585
0,283 Kg/m
(4586)

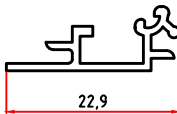

3283
0,133 Kg/m
(3284)

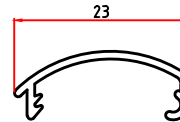

3284
0,106 Kg/m
(3283)

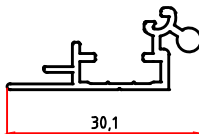

6051
0,210 Kg/m
(6052)

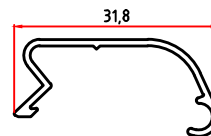

6052
0,168 Kg/m
(6051)

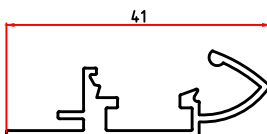

3404
0,292 Kg/m
(3405)

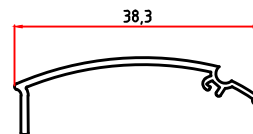

3405
0,153 Kg/m
(3404)

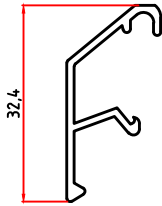

2869
0,215 Kg/m
(2870)

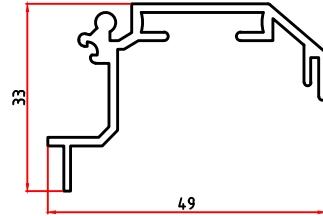

2870
0,544 Kg/m
(2869-3959-4131)

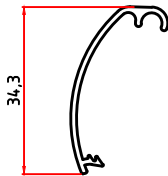

4131
0,189 Kg/m
(2870-4176)

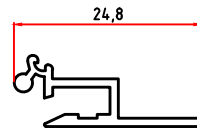

3667
0,145 Kg/m
(2785)

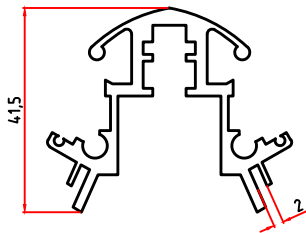

2890
1,075 Kg/m
(2891)



2891
0,161 Kg/m
(2890)

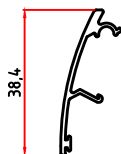

5176
0,230 Kg/m
(5175)

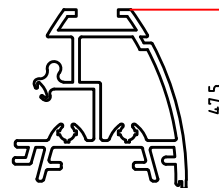

5175
1,265 Kg/m
(5176)

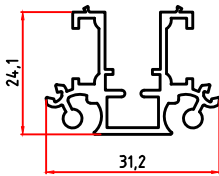

5102
0,550 Kg/m
(5103)

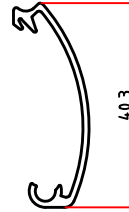

5103
0,232 Kg/m
(5102)

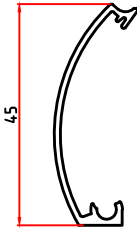

5870
0,250 Kg/m
(5102)

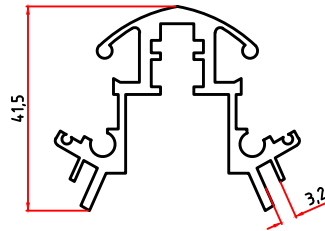

3357
1,075 Kg/m
(2891)

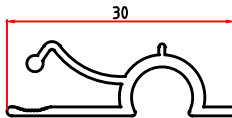

6011
0,205 Kg/m
(6012)

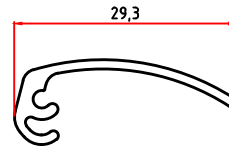

6012
0,175 Kg/m
(6011)

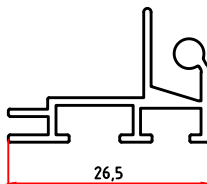

4927
0,250 Kg/m
(4928)

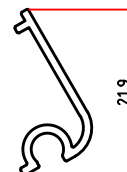

4928
0,117 Kg/m
(4927)

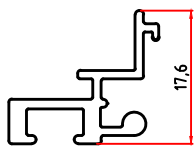

5523

0,215 Kg/m

(5524)

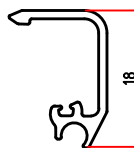

5524

0,129 Kg/m

(5523)

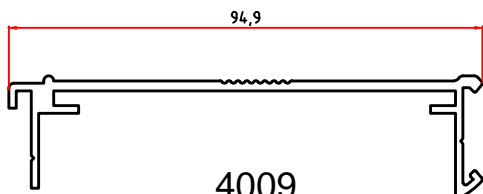

4009

0,825 Kg/m

(4010)



4010

0,082 Kg/m

(4009)

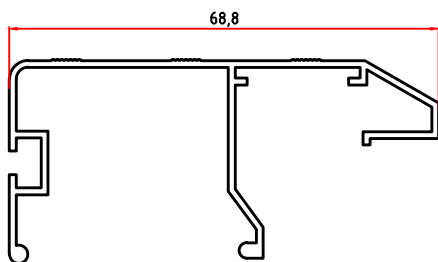

5128

0,567 Kg/m

(5129)

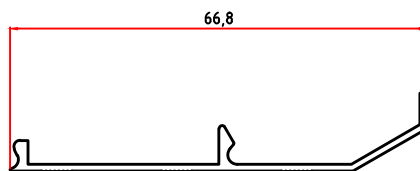

5129

0,282 Kg/m

(5128)

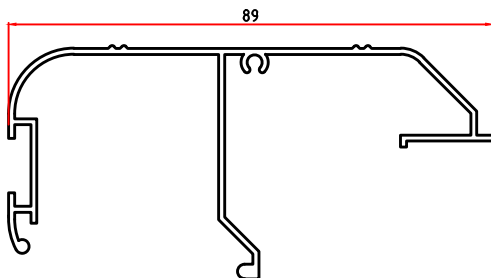

4790

0,692 Kg/m

(4791)

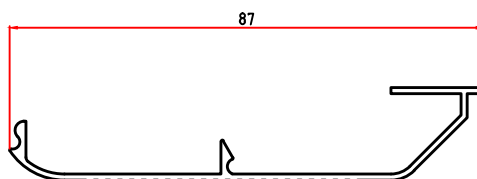

4791

0,426 Kg/m

(4790)

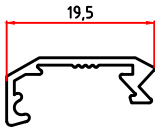

2826

0,116 Kg/m

(2825)

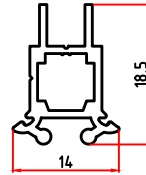

2825

0,191 Kg/m

(2826)

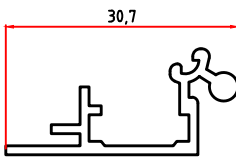

2305

0,243 Kg/m

(2306)

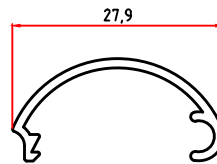

2306

0,162 Kg/m

(2305)

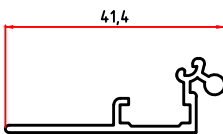

5146

0,268 Kg/m

(5147)

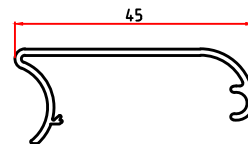

5147

0,273 Kg/m

(5146)

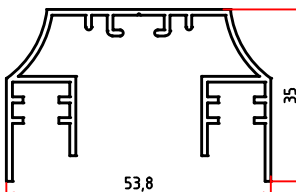

6266

0,684 Kg/m

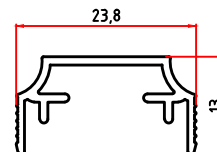

6001

0,178 Kg/m

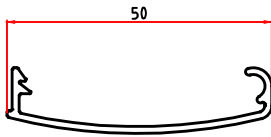

4894
0,272 Kg/m
(4894)

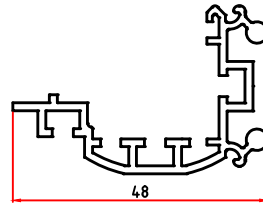

4895
0,645 Kg/m
(4895)

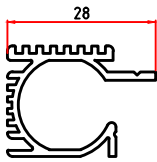

4730
0,368 Kg/m

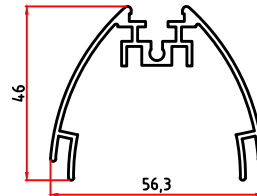

5131
0,796 Kg/m

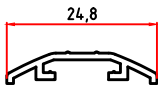

5038
0,117 Kg/m

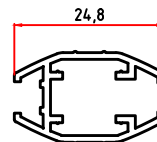

5039
0,256 Kg/m

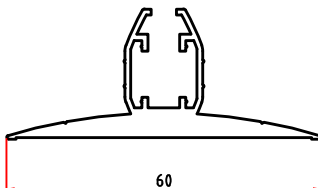

5264
0,769 Kg/m

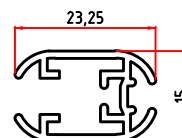

2976
0,296 Kg/m

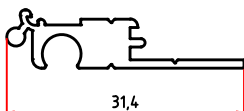

6056
0,247 Kg/m

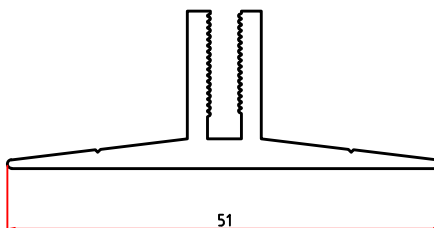

3673
0,567 Kg/m



2786
0,250 Kg/m

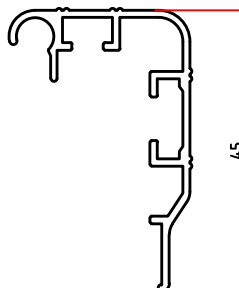

5234
0,388 Kg/m

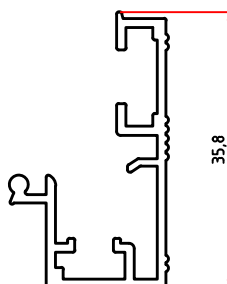

5235
0,345 Kg/m

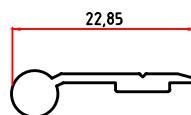

5236
0,146 Kg/m



5237
0,065 Kg/m

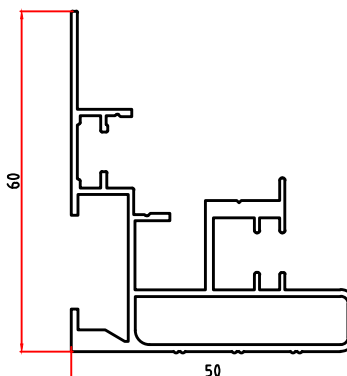

5356
0,922 Kg/m

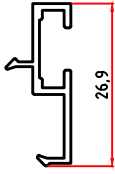

5357
0,160 Kg/m

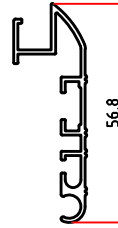

5358
0,429 Kg/m

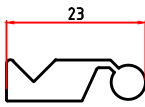

5359
0,318 Kg/m



5458
0,380 Kg/m

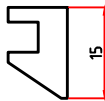

5360
0,273 Kg/m

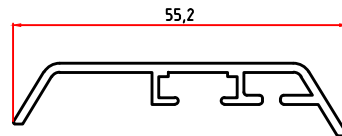

5754
0,371 Kg/m

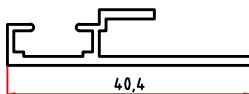

5755
0,275 Kg/m

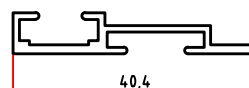

5792
0,245 Kg/m

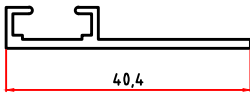

5864
0,230 Kg/m

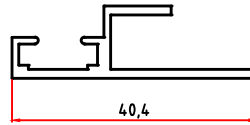

5865
0,305 Kg/m

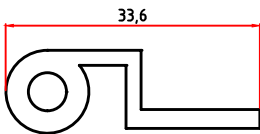

5791
0,428 Kg/m

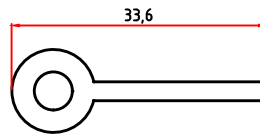

5756
0,376 Kg/m

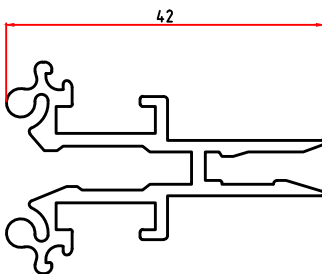

7026
0,646 Kg/m
(7027)

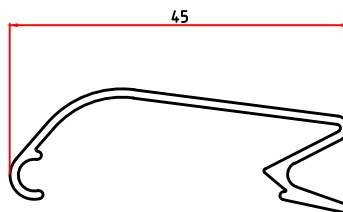

7027
0,267 Kg/m
(7026)

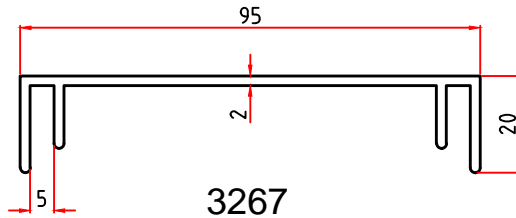

3267
0,888 Kg/m

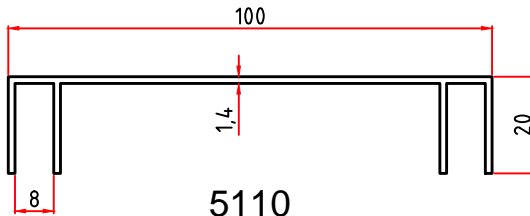

5110
0,662 Kg/m

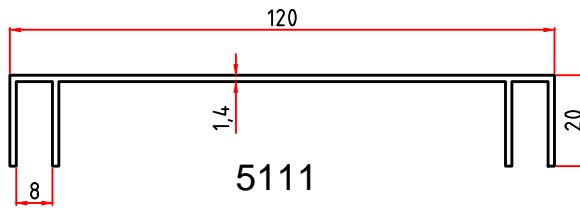

5111
0,738 Kg/m

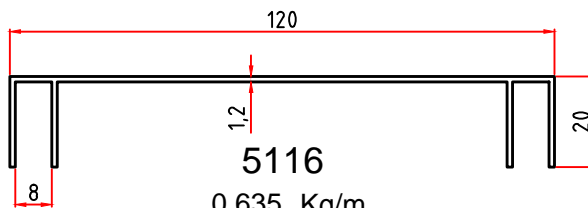

5116
0,635 Kg/m

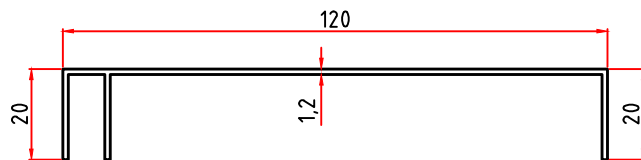

5115
0,574 Kg/m

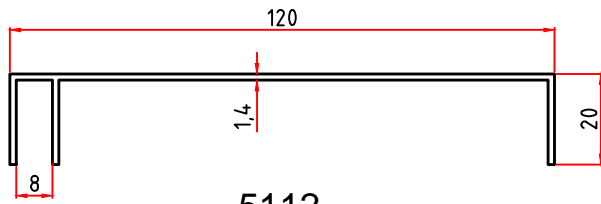

5112
0,667 Kg/m

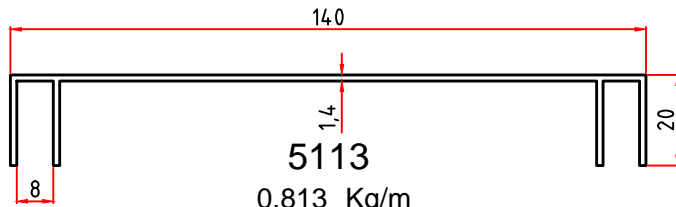

5113
0,813 Kg/m

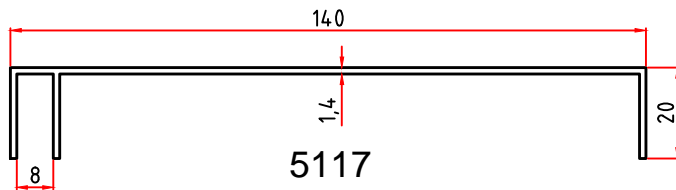

5117
0,743 Kg/m

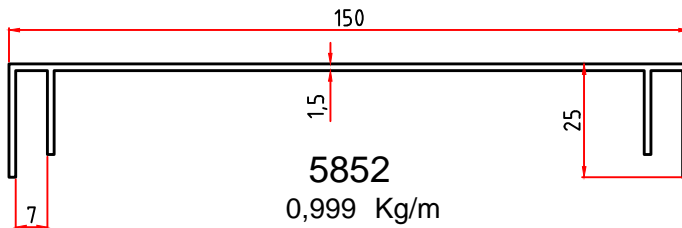

5852
0,999 Kg/m

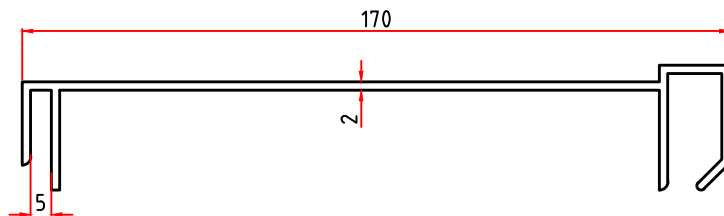

6444
1,533 Kg/m

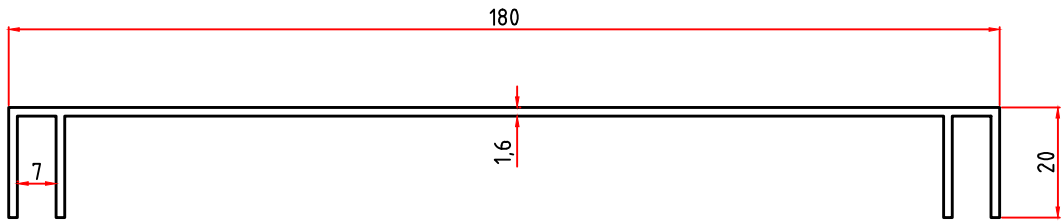

5114
1,100 Kg/m

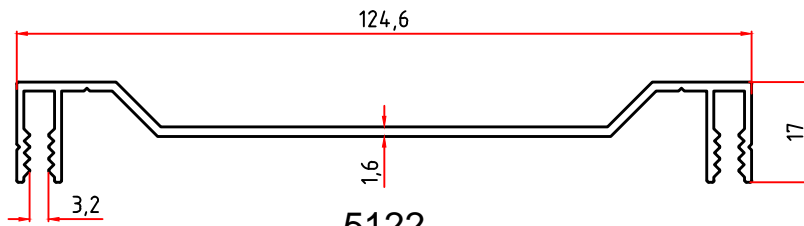

5122
0,842 Kg/m

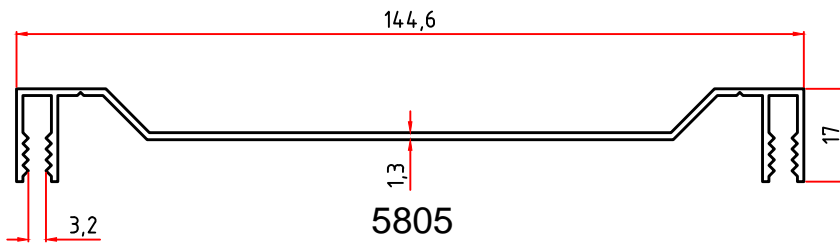

5805
0,803 Kg/m

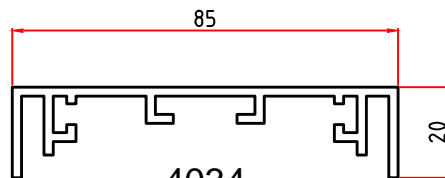

4034
1,046 Kg/m

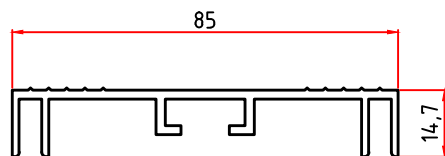

3666
0,834 Kg/m

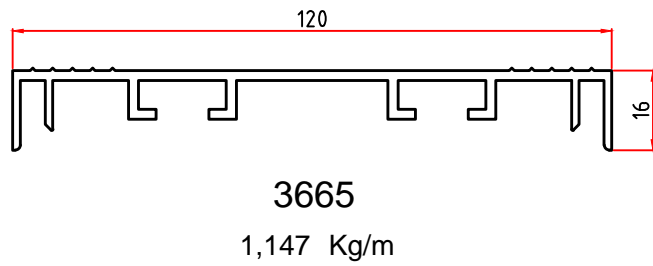
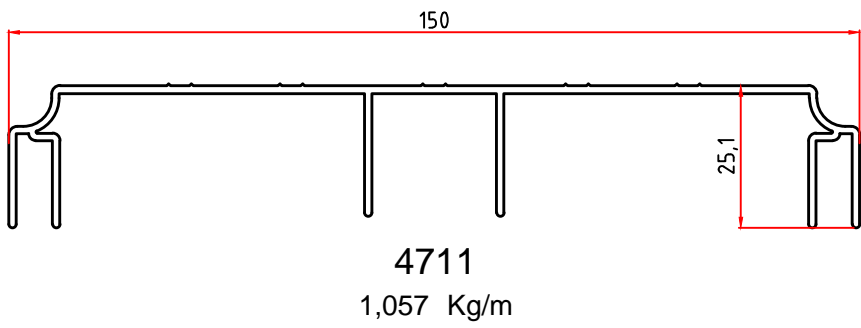
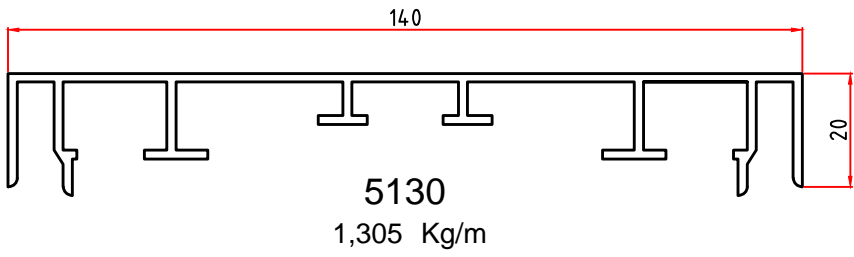
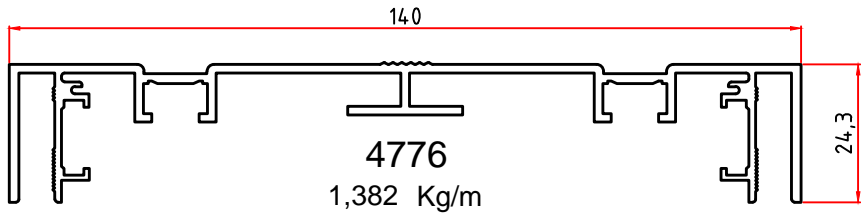
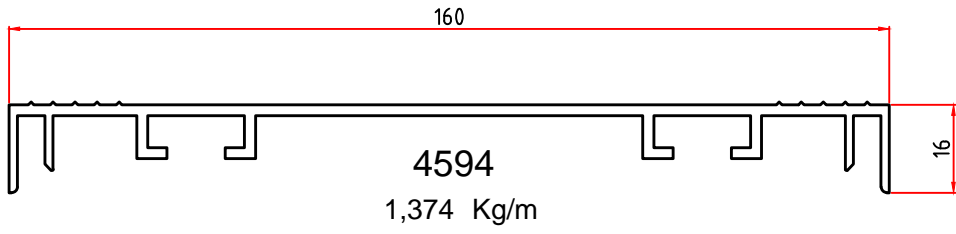

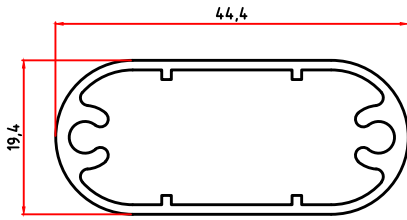

4177
0,522 Kg/m

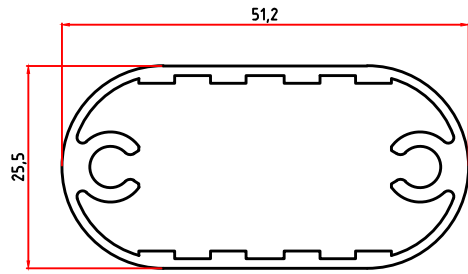

5233
0,748 Kg/m

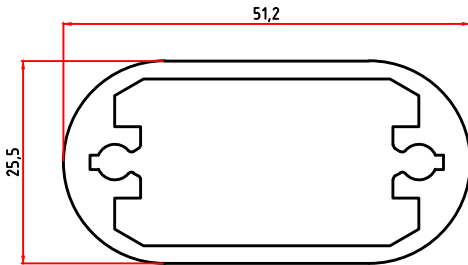

2303
1,119 Kg/m

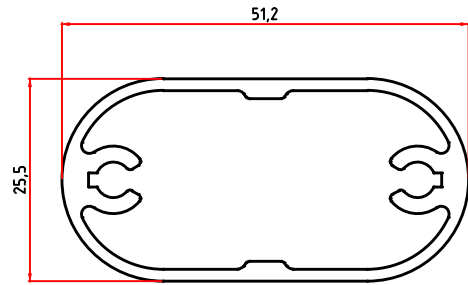

6194
0,798 Kg/m

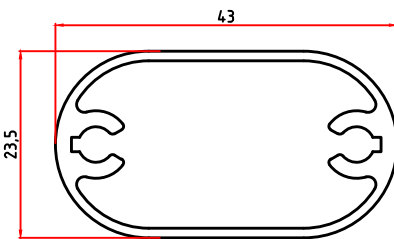

4156
0,571 Kg/m

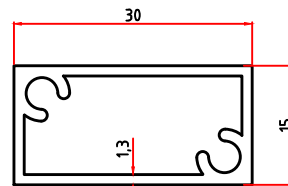

1562
0,378 Kg/m

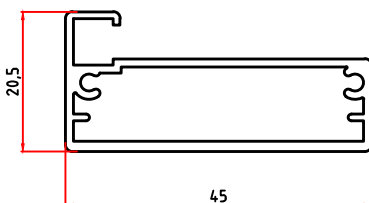

3286
0,519 Kg/m

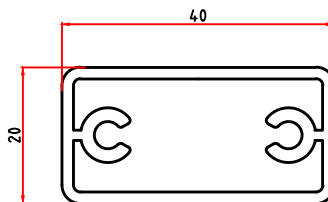

2304
0,719 Kg/m